

RACON, round plunger 8 mm, L 7.5 mm



Description

The wide selection of standard plungers in different shapes and colors guarantees a versatile range of applications for the RACON tactile switch.

technical data

> general

Color	white
Collar shape	round
illuminated	No
Packaging unit	500 pcs.
Net weight	0.1 g
Minimum order quantity (MOQ)	1,000 pcs.
RoHS compliant	Yes
REACH compliant	Yes
Component material	Plastic
Country of origin	DE

direct links

> [RAFI eCatalog](#)

> mounting diameters

Outside dimension, length	9 mm
Outside dimension, width	8 mm
Outside dimension, height	8 mm
Plunger length L	7.5 mm

drawings

Dimensioned drawing

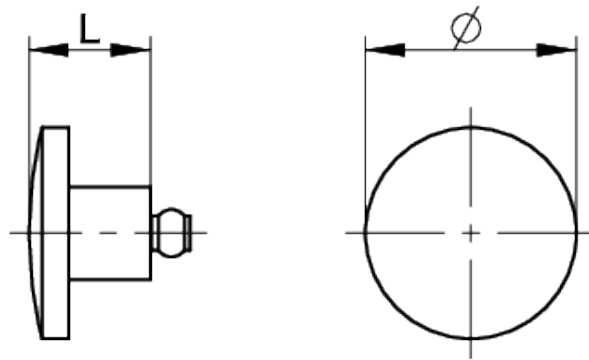

System drawing

SMT gullwing connection

Recommended: Embossing: 0.35 mm

Adhesive thickness: 0.15 mm

