

## RACON, round plunger 11.5 mm, L 2.1 mm

### Description



The wide selection of standard plungers in different shapes and colors guarantees a versatile range of applications for the RACON tactile switch.

### technical data

#### > general

Color	white
Collar shape	round
illuminated	No
Packaging unit	500 pcs.
Net weight	0.2 g
Minimum order quantity (MOQ)	1,000 pcs.
RoHS compliant	Yes
REACH compliant	Yes
Component material	Plastic
Country of origin	DE

#### direct links

> [RAFI eCatalog](#)

#### > mounting diameters

Outside dimension, length	3.6 mm
Outside dimension, width	11.5 mm
Outside dimension, height	11.5 mm
Plunger length L	2.1 mm

**drawings**

**Dimensioned drawing**

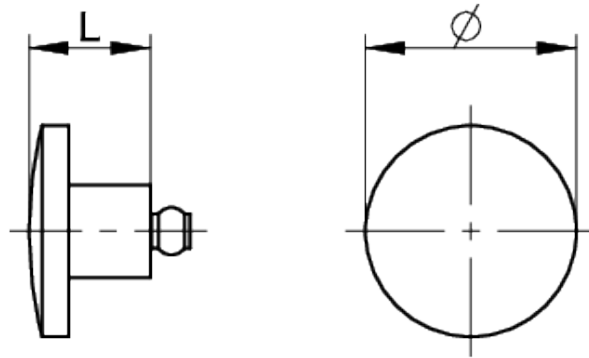

**System drawing**

SMT gullwing connection

Recommended: Embossing: 0.35 mm

Adhesive thickness: 0.15 mm

