

Signal lamp with integrated LED, 5 mm, flat round bezel, 7 Volt, bezel red, Solder terminal



Description

Signal lamps with integrated LED, mounting hole diameter 5 mm



technical data

> general

Bezel color	red
Property of bezel / mushroom	transparent
Bezel shape	round
illuminated	Yes
Packaging unit	10 pcs.
Net weight	0.5 g
Degree of protection, front side, according to DIN EN 60529	IP40
Minimum order quantity (MOQ)	50 pcs.
RoHS compliant	Yes
REACH compliant	Yes
Country of origin	HU

direct links

> [RAFI eCatalog](#)

> mounting diameters

Outside dimension, length	5.9 mm
Outside dimension, width	5.9 mm
Outside dimension, height	22 mm
Mounting hole	5 mm
Mounting depth	18 mm
Installation height	1 mm
Collar dimension	5.8 mm

> mechanical data

Terminal on the rear	Solder terminal
Fixing	Pushing into mounting hole
Solderability	Yes

> electrical data

Operating voltage of the luminous element, min. 5 V

Operating voltage of the luminous element, max. 7 V

drawings

Dimensioned drawing

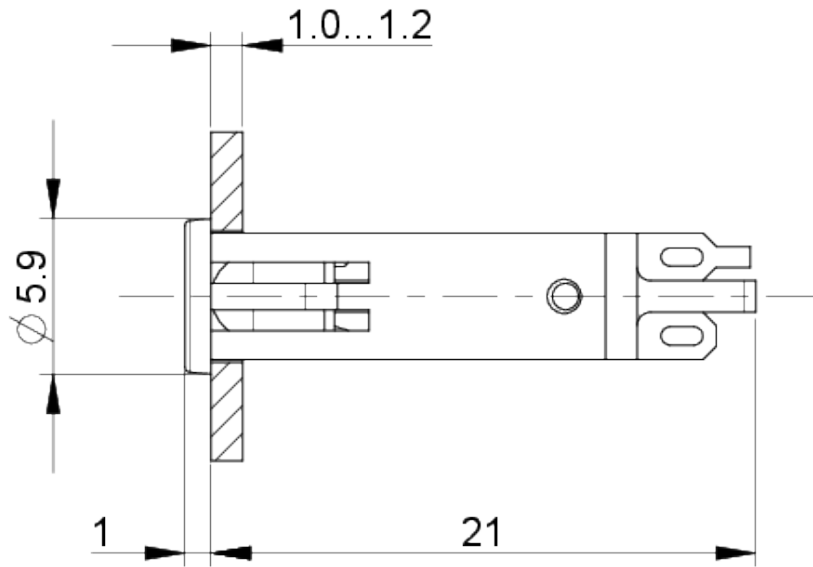

Mounting hole drawing

