

RAFIX 22 FSR, illuminated selector switch, round collar, frontring black, 2 x 40°, momentary contact function, illuminable



Description

The translucent handle marking can be illuminated if combined with a corresponding switching element.

For colored illumination of the handle marking, please use colored LEDs.



technical data

> general

Disassembly possible	no
Front ring color	black
Collar shape	round
Operating temperature, min.	-40 °C
Operating temperature, max.	85 °C
Storage temperature, min.	-40 °C
Storage temperature, max.	85 °C
illuminated	Yes
Packaging	Box
Packaging unit	10 pcs.
Net weight	14 g
Operating life	500,000 cycles
B10	650,000 cycles
Degree of protection, front side, according to DIN EN 60529	IP65 IP69
Degree of protection, front side, according to ISO 20653	IPx9K
Environment resistance	IEC 60068-2-14 IEC 60068-2-30 IEC 60068-2-33 IEC 60068-2-78
Salt-spray resistance according to standard	IEC 60068-2-11
Impact resistance IK	06
Minimum order quantity (MOQ)	10 pcs.
RoHS compliant	Yes
REACH compliant	Yes
Country of origin	HU

> mounting diameters

Outside dimension, length	31.3 mm
Outside dimension, width	31.3 mm

direct links

> [RAFI eCatalog](#)

Outside dimension, height	32.4 mm
Mounting hole	22.3 mm
Mounting depth	9.2 mm
Installation height	23.8 mm
Grid, min.	32 x 32 mm
Collar dimension	ø 31,3 mm

> mechanical data

Fixing	Threaded ring
Actuation function	momentary contact function
Operating torque, max.	2 Nm
Threaded ring torque, max.	1.2 Nm
Rotating angle	2 x 40°

> Specifications according to UL 60947

UL Enclosure Type Rating front	type 1
side	type 4X indoor

Use according to UL:

RAFIX control devices are defined at RAFI as modular elements, consisting of an actuating element, if necessary a coupling and an individual contact or lighting unit.

Actuating elements (such as pushbuttons, emergency stop actuators, etc.) have the intended tactility, reset and function only when assembled with the appropriate switching elements.

drawings

System drawing

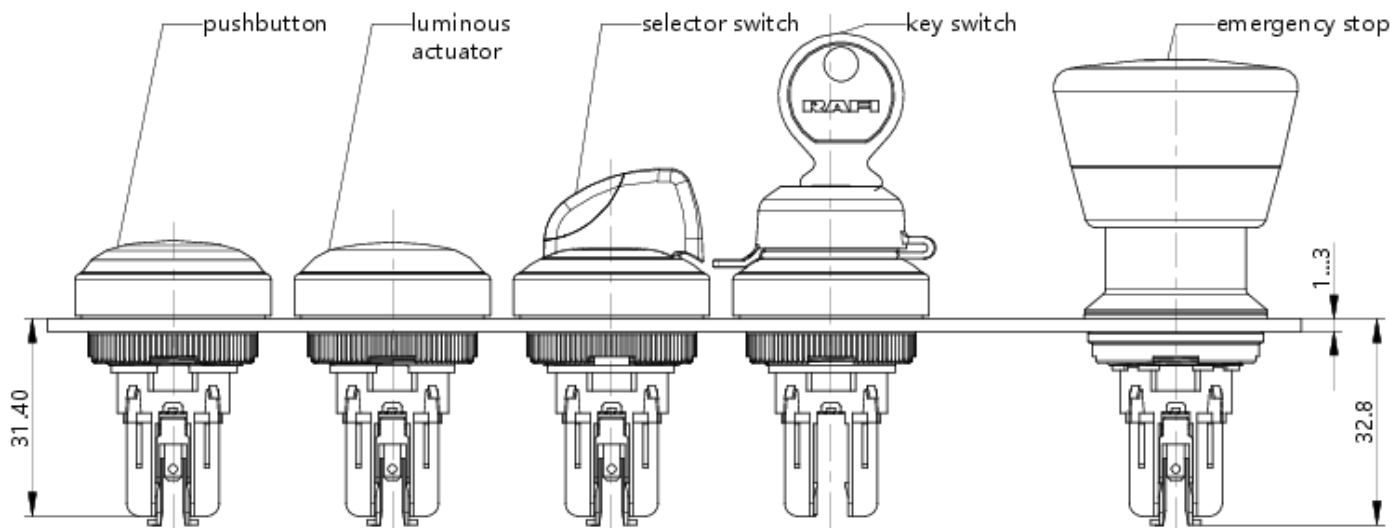

System drawing

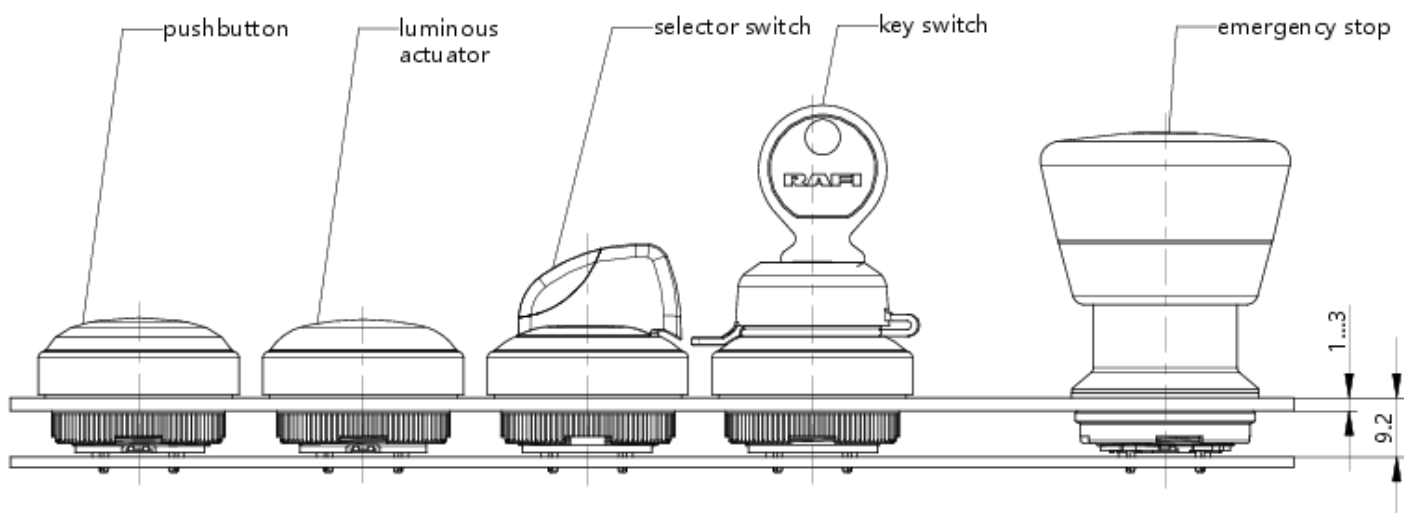

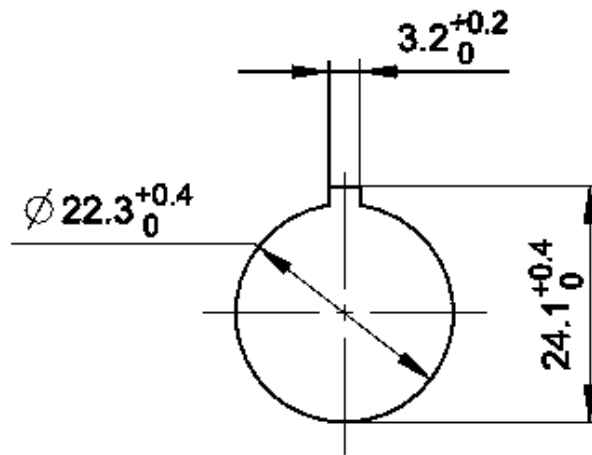
Mounting hole drawing

acc. to IEC 60947-5-1