

RAFIX 22 FS⁺, illuminated selector switch, round collar, frontring black, 2 x 40°, momentary contact function, illuminable



Description

The translucent handle marking can be illuminated if combined with a corresponding switching element.

For colored illumination of the handle marking, please use colored LEDs.



technical data

> general

Disassembly possible	no
Front ring color	black
Collar shape	round
Operating temperature, min.	-25 °C
Operating temperature, max.	70 °C
Storage temperature, min.	-40 °C
Storage temperature, max.	80 °C
illuminated	Yes
Packaging	Box
Packaging unit	10 pcs.
Net weight	10 g
Operating life	500,000 cycles
B10	650,000 cycles
Degree of protection, front side, according to DIN EN 60529	IP65
Environment resistance	IEC 60068-2-14 IEC 60068-2-30 IEC 60068-2-33 IEC 60068-2-78
Salt-spray resistance according to standard	IEC 60068-2-11
Minimum order quantity (MOQ)	10 pcs.
RoHS compliant	Yes
REACH compliant	Yes
Country of origin	HU

> mounting diameters

Outside dimension, length	29.8 mm
Outside dimension, width	29.8 mm
Outside dimension, height	32.4 mm
Mounting hole	22.3 mm
Mounting depth	9.2 mm

direct links

> [RAFI eCatalog](#)

Installation height	22.24 mm
Grid, min.	30 x 30 mm
Collar dimension	ø 29,8 mm

> mechanical data

Fixing	Threaded ring
Actuation function	momentary contact function
Operating torque, max.	1.5 Nm
Threaded ring torque, max.	1.2 Nm
Rotating angle	2 x 40°

> Specifications according to UL 60947

UL Enclosure Type Rating front	type 1
side	type 4X indoor

Use according to UL:

RAFIX control devices are defined at RAFI as modular elements, consisting of an actuating element, if necessary a coupling and an individual contact or lighting unit.

Actuating elements (such as pushbuttons, emergency stop actuators, etc.) have the intended tactility, reset and function only when assembled with the appropriate switching elements.

drawings

Dimensioned drawing

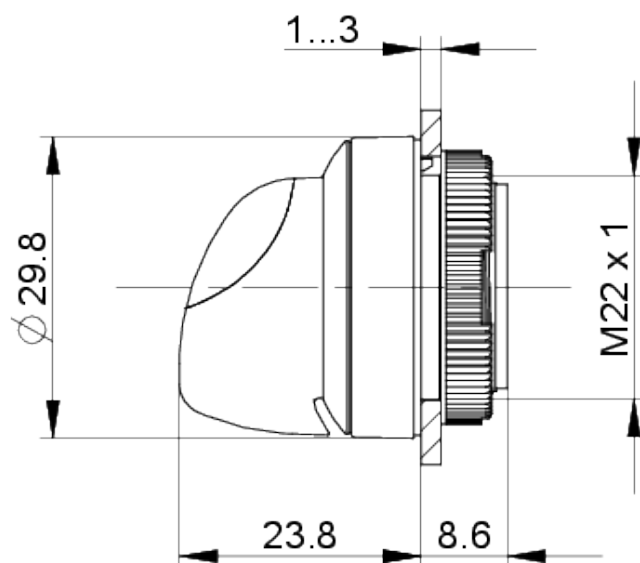

System drawing



System drawing



Mounting hole drawing



acc. to IEC 60947-5-1

front panel drawing

