

RAFIX 22 QR, keylock switch, round collar, frontring metallic silver, 1 x 90°, shape V, latching, key removal position 0



Description

RAFIX control units are modular units consisting of several parts. In the RAFIX 22 QR family, they always consist of an actuating element, coupling and switching element. Then this unit is snapped onto the key switch. To release, a bayonet lever must be actuated.

RAFIX 22QR key switches have the specified tactility and function only when assembled with the appropriate switching elements. You can choose between two collar shapes: round and square. The mounting diameter is 22.3 mm according to the standard. The anti-rotation lug can be easily removed with a screwdriver if necessary.

The locking systems we use were created according to the DIN EN 1303 standard by well-known lock manufacturers. They are open, mechanical systems which, depending on the environmental conditions, require occasional maintenance by the machine or system operator.



technical data

> general

Scope of delivery	2 keys
Front ring color	metallic silver
Collar shape	round
Operating temperature, min.	-25 °C
Operating temperature, max.	70 °C
Storage temperature, min.	-40 °C
Storage temperature, max.	80 °C
illuminated	No
Packaging	Box
Packaging unit	2 pcs.
Net weight	42.5 g
Operating life	50,000 cycles
B10	65,000 cycles
Degree of protection, front side, according to DIN EN 60529	IP65
Environment resistance	IEC 60068-2-14 IEC 60068-2-30 IEC 60068-2-33 IEC 60068-2-78
Protection class	II
Minimum order quantity (MOQ)	10 pcs.
RoHS compliant	Yes
REACH compliant	Yes

direct links

> [RAFI eCatalog](#)

Country of origin	HU
> mounting diameters	
Outside dimension, length	29.8 mm
Outside dimension, width	29.8 mm
Outside dimension, height	53.5 mm
Mounting hole	22.3 mm
Mounting depth	56.4 mm
Installation height	30.6 mm
Grid, min.	50 x 30 mm
Collar dimension	ø 29,8 mm
> mechanical data	
Key removal position	0
Fixing	Threaded ring
Actuation function	latching
Operating torque, max.	2 Nm
Threaded ring torque, max.	1.2 Nm
Rotating angle	1 x 90°, shape V
Locking position	421
Key lock	Ronis

Use according to UL:

RAFIX control devices are defined at RAFI as modular elements, consisting of an actuating element, if necessary a coupling and an individual contact or lighting unit.

Actuating elements (such as pushbuttons, emergency stop actuators, etc.) have the intended tactility, reset and function only when assembled with the appropriate switching elements.

drawings

Dimensioned drawing



System drawing

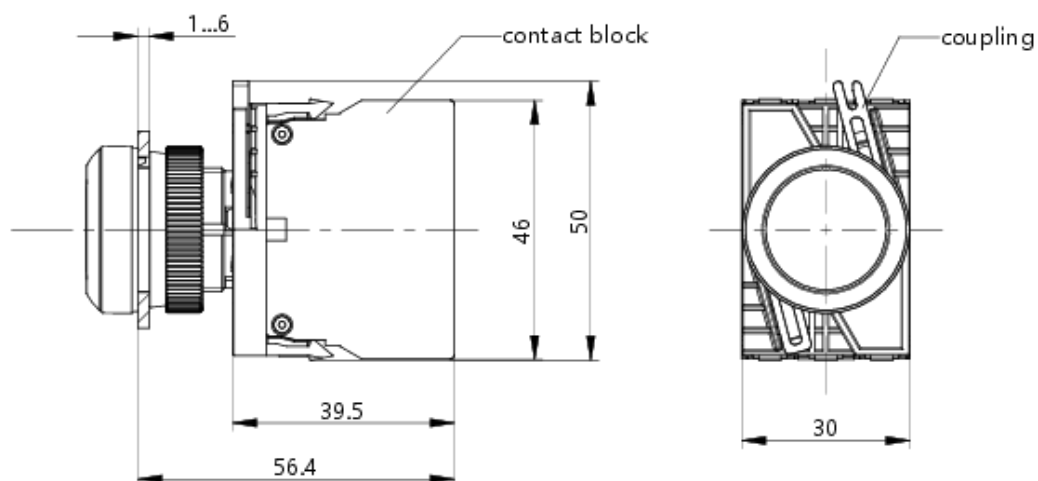

front panel drawing

