

E-BOX XL MODULAR, housing, 5 installation points, 22.3 mm, M20 to the side, light gray



Description

The E-BOX XL MODULAR as a supplement to the E-BOX MODULAR is an enclosure concept with 3 to 6 installation points for all RAFIX 22 FS+/FSR control devices. It is used where individual control devices are required at remote locations - for example, emergency stop applications along a production line or at a safety fence. The compact dimensions of the E-BOX XL are based on the edge dimensions of a 40 mm profile rail. Installation is quick and easy - thanks to the modular system consisting of the lower and upper housing sections, QC contact blocks and RAFIX 22 FS+/FSR actuators, which are installed and wired manually.

Individually configurable and combinable

- Use of RAFIX 22 FS+ actuators and RAFIX 22 FS+ QC switching elements for any installation location
- Manual wiring with cable gland (Ø 7-13 mm clamping range)
- RAFIX 22 FS+ / RAFIX 22 FSR actuating elements, RAFIX 22 FS+ QC switching elements, LED clips and blade receptacles must be purchased separately

Scope of delivery

Lower housing section, upper housing section, cable gland, emergency stop adhesive label and screws for the housing connection

Assembly

Detailed installation instructions for the E-BOX XL MODULAR are available in the "Downloads" section.



technical data

> general

Scope of delivery	Quick-Start-Guide
Installation points	5 pcs.
Color	light gray

Operating temperature, min.	-25 °C
Operating temperature, max.	70 °C
Storage temperature, min.	-40 °C
Storage temperature, max.	80 °C
Packaging	Box
Packaging unit	1 pcs.
Net weight	291 g
Degree of protection, front side, according to DIN EN 60529	IP65
Degree of protection, rear side, according to DIN EN 60529	IP65
Salt-spray resistance according to standard	IEC 60068-2-11
Chemical resistance according to standard	ISO 16750-5
UV resistance according to ISO 4892-2	Method A: Artificial weathering
Impact resistance IK	07 side 07 frontal
Protection class	II
Minimum order quantity (MOQ)	5 pcs.
RoHS compliant	Yes
REACH compliant	Yes
> mounting diameters	
Outside dimension, length	357 mm
Outside dimension, width	42 mm
Outside dimension, height	40 mm
Mounting hole	22.3 mm
> mechanical data	
Terminal on the rear	M20 to the side
Tightening torque screws mounting	2 Nm
Fixing	Screw

direct links[> RAFI eCatalog](#)**Use according to UL:**

For cable gland use only connection cords with cord dia., in (mm) 0.43 - 0.51 (11 - 13) to maintain the cable glands recognized type rating.

Installation points are to be closed with suitable actuators of RAFI GmbH & Co. KG E64839 or E214155 min. rated UL50/UL50E type 1 or type 4X indoor use only.

drawings

Dimensioned drawing



Dimensioned drawing

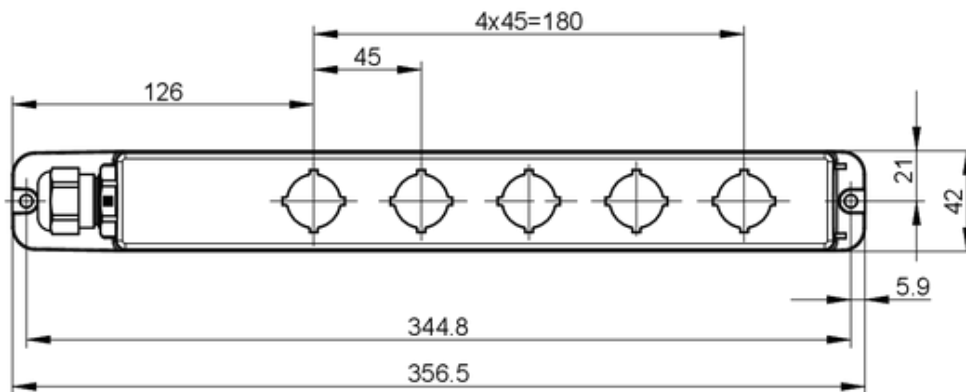

System drawing

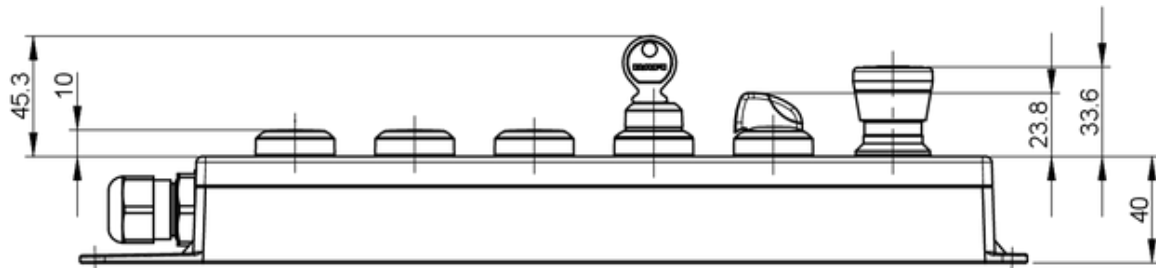

System drawing

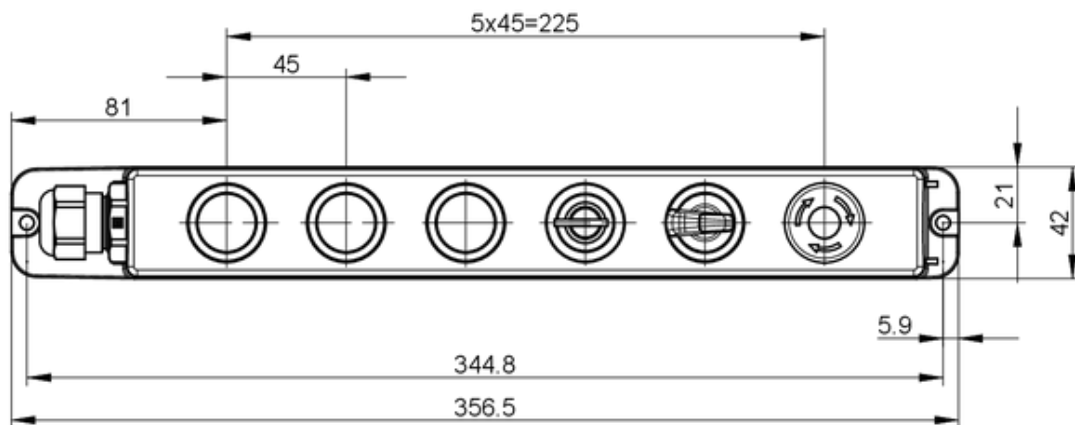

mounting

**E-BOX XL MODULAR
OPERATING MANUAL**

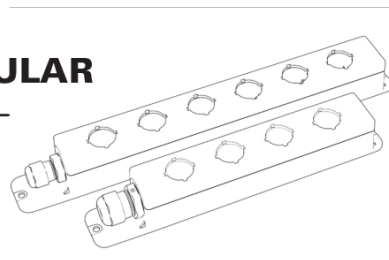

1. Safety

1.1 Use

The RAFI E-BOX XL MODULAR is an housing system in which control and signaling devices can be custom installed according to the requirements of the machine or system, allowing the operator to control such a system. To ensure safe operation and prevent personal injury, the E-BOX XL MODULAR housing system must be securely bolted to the system or machine by the installer using all the screw connections provided.

Use of the E-BOX XL MODULAR for purposes other than those for which it is intended will invalidate its associated declaration of conformity. The E-BOX XL MODULAR is not subject to the Machinery Directive.

Emergency stop buttons can also be installed in the housing system. These are electromechanical switching devices for the protection of persons on or near machines. They are used to switch off/shut down machines and systems in order to avoid or reduce emerging or existing hazards for persons or damage to the machine or the workpiece.

For installation and commissioning, as well as regular technical inspections, the (inter)national legal regulations apply, in particular

- The Low-Voltage Directive 2014/35/EU
- The safety regulations, and
- The accident prevention regulations/safety rules

Manufacturers and operators of machines on which emergency stop buttons are used are responsible for observing the operating manual for emergency stop control components, as well as for complying with the applicable safety regulations and rules.

! In particular, the relevant requirements for the installation and operation of emergency stop buttons must be observed for the intended use:

- EN 60204-1
- EN13849-1
- EN ISO 13850

! Disconnect the system and device from the power supply before starting installation.

If an emergency stop button is installed in the E-BOX XL MODULAR, the safety instructions in the operating instructions for the emergency stop button must be observed.

1.2 Safety provisions

This operating manual applies to the housing systems of the E-BOX XL MODULAR series and the correct assembly of the associated actuators and switching elements. When installing emergency stop buttons, the separate operating manual for the emergency stop device must be observed. The operating manual must be made available to the person installing the housing system with actuators, switching elements, and optional emergency stop. Please read it carefully and keep it for future reference.

1.3 Approvals and technical data

See information on the respective actuators and switching elements in the eCatalog and on the technical data sheet.

2. Product description

2.1 Housing

This operating manual applies to the following housing systems:

Article no.	Description
1.20.810.530/0000	Housing, 3 installation points 22.3mm, M20 cable gland
1.20.810.540/0000	Housing, 4 installation points 22.3mm, M20 cable gland
1.20.810.550/0000	Housing, 5 installation points 22.3mm, M20 cable gland
1.20.810.560/0000	Housing, 6 installation points 22.3mm, M20 cable gland

2.2 Possible actuators and switching elements

Only the following actuators and switching elements from RAFI GmbH & Co. KG may be used with the E-BOX XL MODULAR housing system. Failure to comply with this requirement will invalidate the declaration of conformity and approval of the E-BOX XL MODULAR:

Number range	Series	Type
1.30.27x.xxx/yyyy	RAFIX 22 FS*	Emergency stop, pushbutton, selector switch, keylock switch, signal indicator
1.30.28x.xxx/yyyy	RAFIX 22 FSR	Emergency stop, pushbutton, selector switch, keylock switch, signal indicator
1.20.126.5xx/yyyy	RAFIX FS switching element QC emergency stop	Switching elements of the QC series as normally closed contacts and normally open contacts, with gold contacts
1.20.126.70x/yyyy	RAFIX FS switching element QC emergency stop	Switching elements of the QC series as normally closed contacts and normally open contacts, with silver contacts
1.20.126.10x/yyyy	RAFIX FS switching element QC Universal	Switching elements of the QC series as normally closed contacts and normally open contacts, with gold contacts
1.20.126.30x/yyyy	RAFIX FS switching element QC Universal	Switching elements of the QC series as normally closed contacts and normally open contacts, with silver contacts

2.3 Scope of delivery

The scope of delivery of the E-BOX XL MODULAR includes:

- Housing upper part
- Housing bottom part
- M20 cable gland
- Emergency stop adhesive sign
- Delta screws for housing screw connection

The scope of delivery does not include screws for fixing the housing system.