

RACON 12 i, THT, 3.3 ± 0.6 N, bezel orange, 1 NO



Description

Flat data entry keyboards with RACON 12 i-elements should be constructed in a 15.24 mm grid. With this grid, strips of glue remain between the individual keys on the front panel. The overlay, which we recommend embossing above the key switches, can be glued onto these strips of glue. When using our RK 90 system design, we recommend 9 x 9 mm keycaps.



technical data

> general

Bezel color	orange
Luminous element color	orange
Operating temperature, min.	-40 °C
Operating temperature, max.	80 °C
Storage temperature, min.	-50 °C
Storage temperature, max.	85 °C
illuminated	Yes
Soldering time for manual soldering, max.	5 sec
Soldering temperature for manual soldering	350 °C
Soldering temperature for wave soldering	260 °C
Soldering	Manual / wave
Solder heat resistance according to standard	DIN EN 60068-2-20
Packaging unit	45 pcs.
Net weight	1.6 g
Operating life	1,000,000 cycles
B10	1,300,000 cycles
MSL Moisture Sensitivity Level	1
Minimum order quantity (MOQ)	270 pcs.
RoHS compliant	Yes
REACH compliant	Yes
Component material	Elastomer
Country of origin	HU

> mounting diameters

Outside dimension, length	11.35 mm
Outside dimension, width	11.35 mm

direct links

> [RAFI eCatalog](#)

Outside dimension, height	13.2 mm
Installation height	9.7 mm
Grid, min.	12.5 x 12.5 mm

> mechanical data

Terminal on the rear	THT
Actuation function	momentary contact function
Operating force, min.	3.3 ± 0.6 N
Contact function	1 NO
Contact system	Snap-action contact SPST - Single Pole Single Throw
Contact material	Gold
Solderability	Yes
Switching travel	0.34 ± 0.1 mm

> electrical data

Operating voltage of the luminous element, max.	1.9 V
Rated voltage, min.	0.02 V
Rated voltage, max.	35 V
Dielectric strength	750 V
Operating current of the luminous element, max.	50 mA
Rated current, min.	0.00001 A
Rated current, max.	0.1 A
Rated power, max.	1 W

drawings

Dimensioned drawing

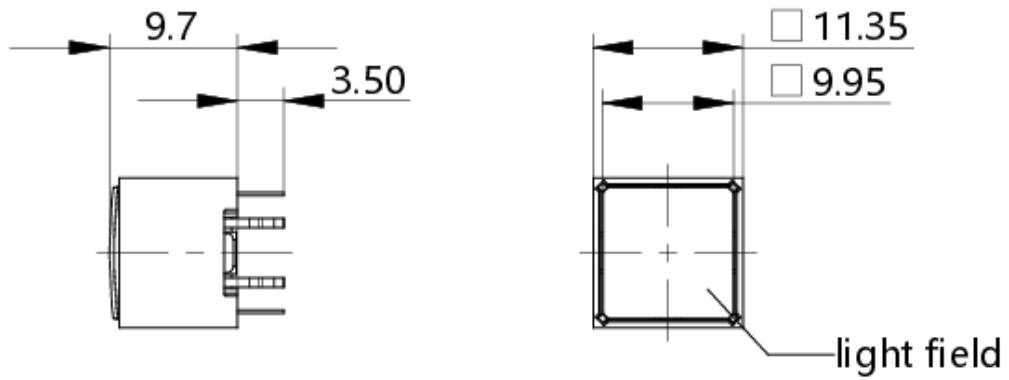

System drawing

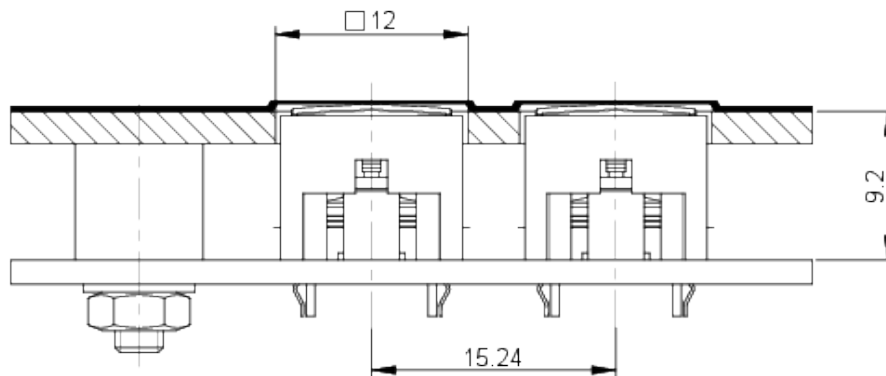

PCB drawing

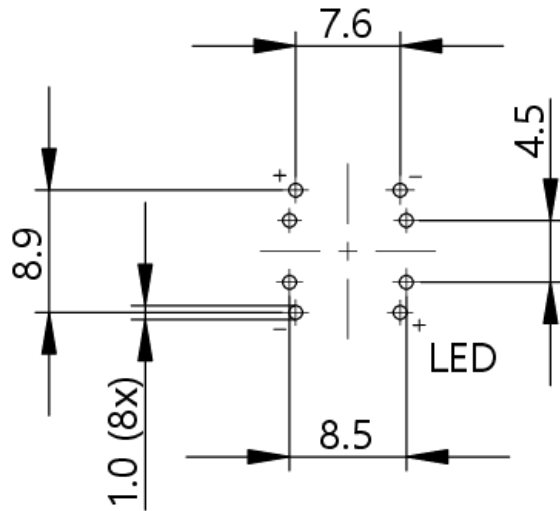

View on component side

PCB drawing

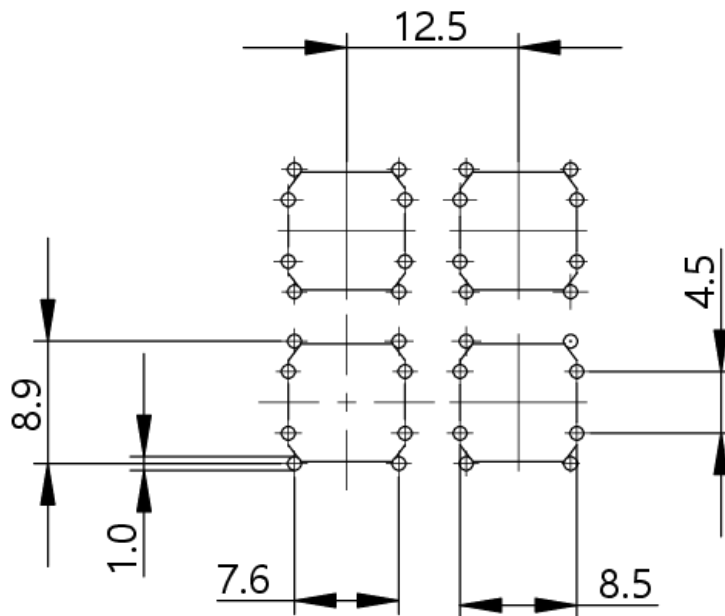

View on component side

Schematic diagram

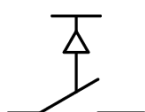
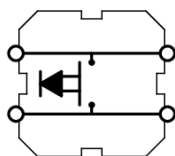

Circuit symbol according to IEC 60 617
Form X (double break)

Circuit diagram

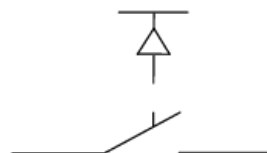
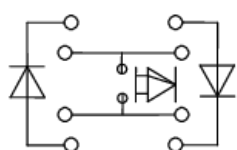

Circuit symbol according to IEC 60 617
Form X (double break)